



ATS200 USER GUIDE



ATID Co.,Ltd
Ver 0.1

Contents

BEFORE THE BEGINNING	5
PRODUCT OVERVIEW	5
KEY FEATURES.....	6
BEFORE USE	7
1. PRECAUTIONS FOR CHARGING.....	7
2. PRECAUTIONS FOR USE.....	8
3. OTHER CAUTIONS AND NOTES	9
PRODUCT SPECIFICATION	10
CONFIGURATION OF THE PRODUCT	11
1. PRODUCT COMPONENTS	11
2. NAME OF EACH PART.....	11
HOST DEVICE INSTALLATION	12
1. USB CABLE CONNECTION	12
2. SMARTPHONE MOUNTING	13
REMOVING AND INSTALLING GUN HANDLE	14
1. REMOVING THE GUN HANDLE.....	14
2. INSTALLING GUN HANDLE.....	14
LED INDICATION BY STATUS.....	15
BUTTON OPERATION.....	16
1. POWER ON.....	16
2. POWER OFF	16
3. DATA COMMUNICATION MODE SETTING	16
4. SWITCH BARCODE / RFID FUNCTION.....	16
CHARGING	17
1. CHARGE USING THE ADAPTER	17
2. CHARGING WITH PC USB PORT	17
3. CHARGING WITH CRADLE	17
4. CHARGING THE GUN HANDLE.....	18
5. SUPPORT FOR SIMULTANEOUS CHARGING OF SMARTPHONES.....	18

BLUETOOTH DATA COMMUNICATION MODE SETTING.....	19
1. ENTER SETTING MODE	19
2. LED INDICATION FOR EACH BLUETOOTH MODE	19
USB DATA COMMUNICATION MODE SETTING.....	20
1. ENTER SETTING MODE	20
2. LED INDICATION FOR EACH USB MODE	20
SETTING MODE BY SCANNING BARCODES.....	21
1. FUNCTIONAL DESCRIPTION.....	21
2. HOW TO SET UP.....	21
3. MODE SETTING BARCODE	22
USING ANDROID HOST DEMO APPLICATION	23
1. ANDROID HOST – BLUETOOTH CONNECTION	24
2. ANDROID HOST – BLUETOOTH DISCONNECTION.....	26
3. ANDROID HOST – REMOVE BLUETOOTH CONNECTION INFORMATION.....	26
4. ANDROID HOST – USB CONNECTION.....	27
5. ANDROID HOST – USB DISCONNECTION.....	29
6. ANDROID HOST – REMOVE USB CONNECTION INFORMATION.....	29
7. ANDROID HOST - RFID TAG SCAN	30
8. ANDROID HOST – BARCODE SCAN	31
9. ANDROID HOST – DEMO APPLICATION MENU	32
USING WINDOWS HOST DEMO APPLICATION	33
1. WINDOWS HOST – BLUETOOTH CONNECTION	33
2. WINDOWS HOST - WINDOWS 7 PLATFORM	33
3. WINDOWS HOST - WINDOWS 10 PLATFORM.....	35
4. WINDOWS HOST - USB CONNECTION	38
5. WINDOWS HOST – DEMO APPLICATION CONNECTION	39
6. WINDOWS HOST - RFID TAG SCAN	40
7. WINDOWS HOST – BARCODE SCAN	41
USING IOS HOST DEMO APPLICATION.....	42
FIRMWARE UPDATE.....	43
1. FIRMWARE UPDATE PREPARATION.....	43
2. FIRMWARE UPDATE PROCEDURE.....	43



SDK (SOFTWARE DEVELOPMENT KIT)	46
PRODUCT WARRANTY	47
1. ATS200 PRODUCT DETAILS.....	47
2. SDK DOWNLOAD.....	47
3. WARRANTY AND TECHNICAL SUPPORT.....	47
4. CERTIFICATIONS	47

Before the Beginning

The objective of user guide is to pass the basic contents related with **ATS200**'s maintenance and smooth uses. User guide inclusive of text, images, logos, product name may not be distributed, modified, displayed, reproduced (in whole or in part) without the prior written permission of **ATID Co.,Ltd.** Furthermore, the described contents in this document are subject to change without notice for improving or maintaining the product and we inform the user that some material can be different with the described contents due to the firmware changes of product.

Ownership of text, images, logos, product name in user guide is included in writer and some parts of text, images, logos, product name in the user guide were borrowed for user's understanding at random. if there is a legal restriction such as a copyright law, it will be redistributed after adjustment.

Product Overview

ATS200 is a SLED-type barcode/RFID reader product. This product meets the basic performance of industrial products that can be used in waterproof/dustproof/dustproof and 1.5m drop tests above IP65 and can be used as data collectors in various fields, including medication management, inventory management, logistics delivery/tracking, production and access control.

This product can collect 1D/2D barcode and UHF RFID Tag information from one device. The collected data can be sent to the Host device via Bluetooth or USB transfer. SDK is supported for easy processing of collected data on host devices with Windows, Android, and iOS.



Key Features

- 1) This product is an SLED type barcode/RFID reader.
- 2) The host device can be fixed on the top of the product using the double-sided tape included in the device, and communication is possible with a USB Type-C to USB Type-C cable.
- 3) It is a durable industrial product that meets IP65 and 1.5m drop standards.
- 4) Zebra (formerly Motorola)'s SE4710 barcode engine is adopted, enabling fast and accurate barcode data collection.
- 5) R2000 module from Impinj is built in, so UHF RFID Tag can be read-written.
- 6) 1 dBi Circular Polarization antenna is applied, so it is easy to read tags from a long distance regardless of direction.
- 7) Using a USB Type-C Cable, data communication and charging are possible by connecting to a PC.
- 8) Even without a dedicated charging adapter, it can be charged using a regular smartphone charger.

Before Use

- Be sure to read and use safety precautions before using them.
 - If there is any problem or inconvenience during use, please contact your dealer or place of purchase.
- 
- Please ensure that the following is used more safely and correctly to prevent accidents and physical damage.
 - The user is responsible for any injury caused by the user who did not follow this instruction, so please be sure to observe it.

1. Precautions for Charging

- 1) It is very dangerous to use a charger with a damaged cord, so please replace the charger with a new one.
- 2) Do not bend the power cord too much or keep it pressed by heavy objects.

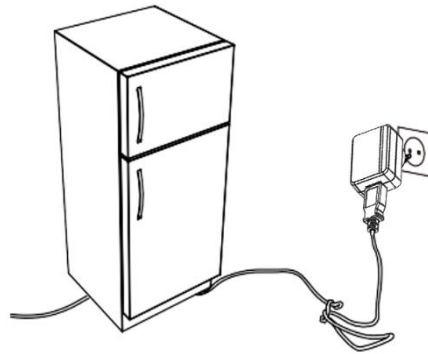
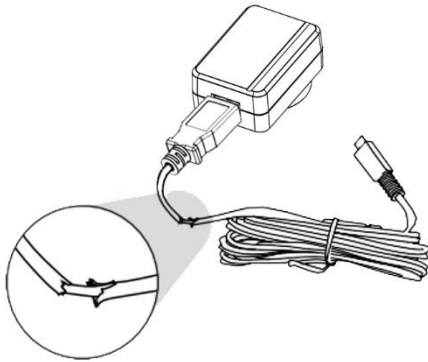

- 3) Do not plug multiple power outlets at the same time. (This may cause a fire or electric shock.)
- 4) Do not touch the power plug with wet hands or pull the cord out. (This may cause electric shock and short circuits.)

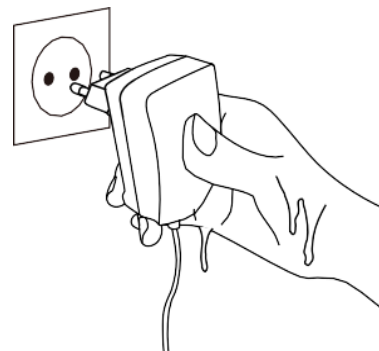
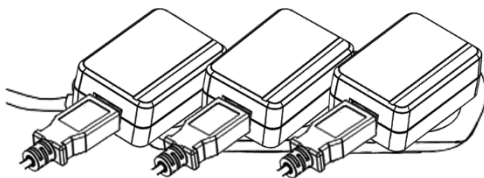

2. Precautions for Use

- 1) Wipe the surface of the product lightly with a dry towel, and do not use chemicals or cleaning agents as they will deteriorate the surface and peel off the paint.

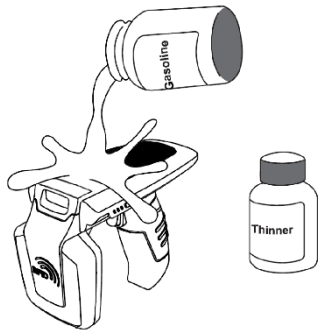

- 2) Avoid high temperatures such as direct sunlight and near heating appliances. If the product or charger smokes or smells strange, stop using it immediately and contact your dealer or purchaser. (This may cause a fire or electric shock.)



- 3) Do not spray water directly on each part of the product during cleaning. (This may cause a fire, electric shock, or failure.)
- 4) Do not use in places where there is a lot of moisture, dust, or soot. (This may cause a fire, electric shock, or failure.)

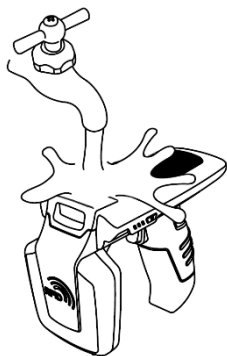

- 5) Do not modify, remove, or repair it arbitrarily. We are not responsible for any accidents caused by it.
- 6) Keep away from home appliances, vibrations, or magnetic types. (This may cause product malfunction.)

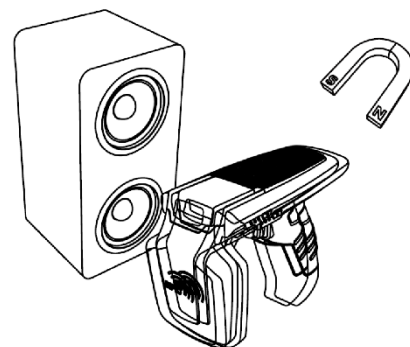
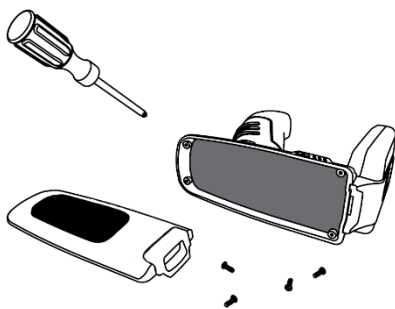

3. Other Cautions and Notes

1) Notes on handling

- Do not use highly volatile substances such as insecticides near this product.
- Be careful not to leave rubber or plastic products in contact with this product for a long time, as marks may be formed.
- If the product is used for a long time, the product may generate heat, but please rest assured that this is not a malfunction.

2) Precautions for using Lithium-ion Batteries

- This product uses a Li-ion battery.
- The lifespan of the battery varies depending on the period of use and usage, and the usage time gradually shortens after purchase.
- When not in use for a long time, fully charge the battery about once every 3 months and store it separately from the product.
- The warranty period of the battery is 6 months from the date of shipment. Batteries are consumables, so if any problems arise during use, please contact the place of purchase.

3) Provision of delivery charges related to initial defects and repairs

- Initial defect (15 days after receiving the product) : ATID bears the return shipping cost.
- Within the free repair period (excluding product damage) : One way is borne by our company.
- Paid repair period (after the warranty period) : The customer bears the return shipping cost.

4) No fast charger available

A/S is not available for problems that occur when using the fast charger.



Since the radio equipment may interfere with radio waves, this device cannot provide services related to human safety.

Product Specification

Performance	
Processor	ARM7 Core
Supported Platforms	Windows, Android, iOS (BLE Only)
Internal Storage	-
Physical Characteristics	
Dimensions (W x L x H)	76.1 x 173.7 x 139.8 mm
Weight	420g (With Battery)
Power	5,200mAh Lithium-Ion Battery (Rechargeable)
Display	-
USB Interface	2 USB Type-C Port (Charging, Data Communication / Host Connection)
Notification	LED Indicator, Buzzer, Vibrator
Data Collection	
Protocol	EPC GEN2, ISO/IEC 18000-6C
Reading Range	~ 6m (Depending on environment and tag type)
Writing Range	~ 0.5m
RF Output	1W (MAX)
RFID (UHF)	US / FCC : 902MHz ~ 928MHz
	EU / CE : 865MHz ~ 868MHz
Frequency Range	KR / KC : 917MHz ~ 921MHz
	JP / TELEC : 916MHz ~ 921MHz (1W)
	: 916MHz ~ 924MHz (0.25W / Optional)
Antenna	Circular Antenna / 1dBi
Barcode	2D Engine (Support to read 1D & 2D Barcode)
Communication	
Bluetooth	BT V2.1+EDR / BLE V4.1
WLAN	-
User Environment	
Operating Temp	-20°C to 50°C
Storage Temp	-30°C to 70°C
Charging Temp	0°C to 45°C
Humidity	5~95% (non-condensing, +25°C)
Drop Spec	1.5m
Sealing	IP65

Configuration of the product

1. Product Components



Product Body



Gun Handle
(Built-in Battery)



USB Cable (Type-C)



Hand Strap

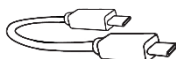

USB Type-C to Type-C



Double-sided tape



Cradle

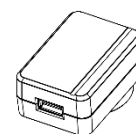

Charging Adapter

2. Name of each part

- 1 : Power Button
- 2 : Communication Mode Switch Button
- 3 : Reset Button
- 4 : Trigger
- 5 : Top Cover
- 6 : Barcode Scanner
- 7 : RFID Antenna
- 8 : Barcode / RFID Toggle Button
- 9 : Charging LED
- 10 : Barcode / RFID LED
- 11 : Communication Mode LED
- 12 : Hand Strap Connection Hole
- 13 : USB Port (Type-C)
- 14 : Gun Handle Release Button
- 15 : Gun Handle (Built-in Battery)
- 16 : Cradle Connection Terminal
- 17 : Top Cover release button
- 18 : Cable Holder

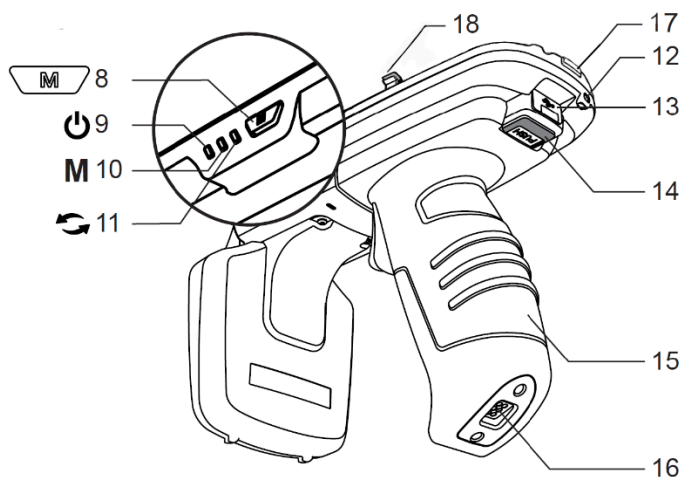
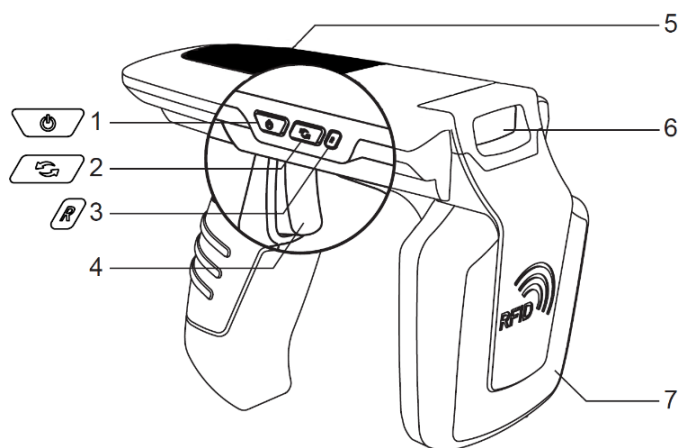

Host Device Installation

1. USB Cable Connection

- 1) If you lift the top cover while pressing the button on the back of the product, the top cover will be removed.
- 2) Connect the host connection cable included with the product to the exposed USB port when the Top Cover is removed as shown below.

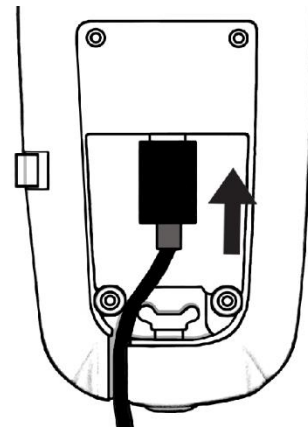
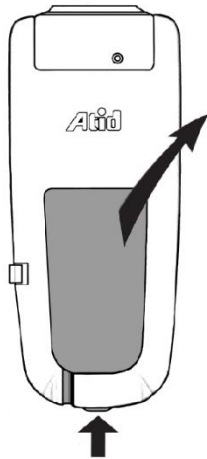

- 3) After completing the USB cable connection, reattach the Top Cover.

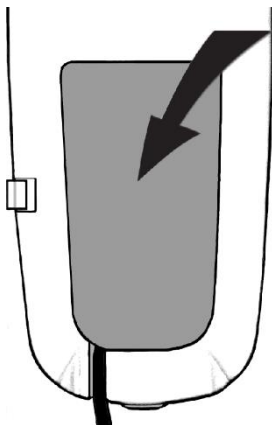

2. Smartphone Mounting

- 1) Attach the double-sided tape included with the product to the Top Cover.
- 2) Attach the smartphone to the top of the device.

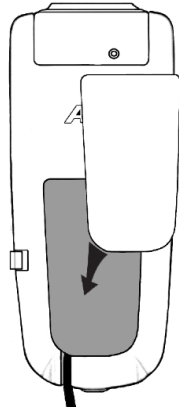

- 3) Connect the USB cable to the smartphone USB connection port.

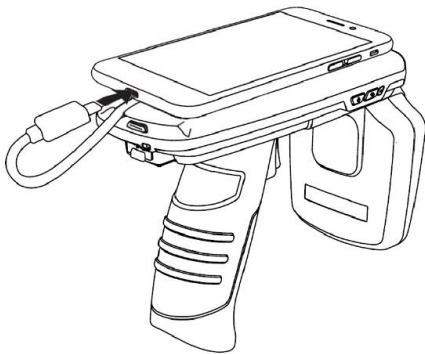

The USB cable does not need to be connected unless charging or data communication via the USB port is desired. Please decide whether to connect or not according to the environment of use.

Removing and Installing Gun Handle

1. Removing the Gun Handle

- 1) Press the gun handle release button.
- 2) Push gun handle back.

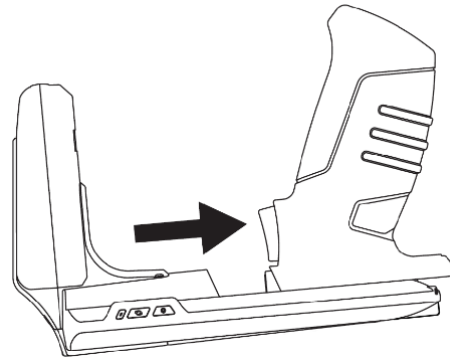
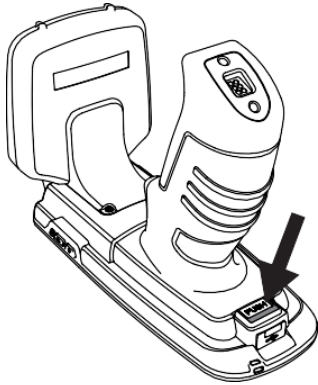

- 3) Pull the gun handle up.

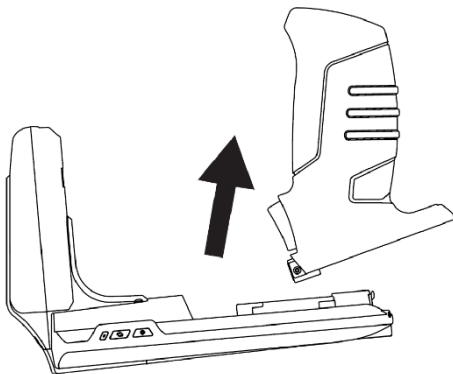

Be careful not to injure your hands while removing the gun handle.

2. Installing Gun Handle

- 1) Attach the gun handle to the **ATS200** body.
- 2) Install the gun handle by sliding it forward. (The button with 'PUSH' written on it with a click sound must come up to ensure it is properly installed.)

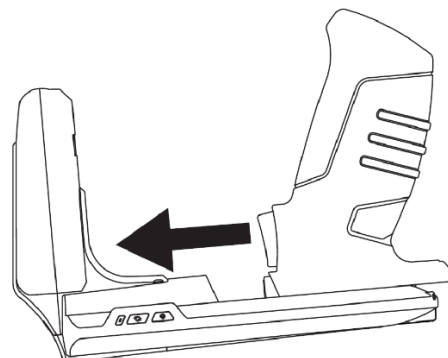
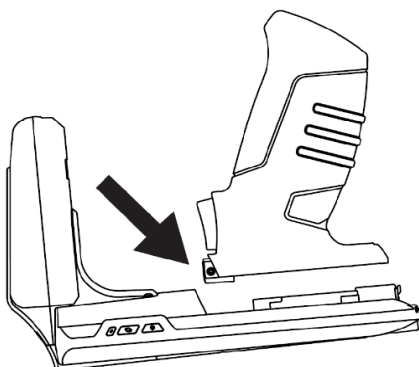

LED Indication by status

ATS200 displays the current device settings or status as shown below with LED operation.

LED	Action	Function
Charging LED	Blinking Red LED	Low Battery
	Red LED On	Charging
	Green LED On	Full Charging
Barcode / RFID LED	Blue LED On	Barcode Mode
	Blinking Blue LED	Trigger Input Mode
	LED Off	RFID Mode
Communication Mode LED	Blinking Green LED	Bluetooth Mode
	Blinking Red LED	USB Mode

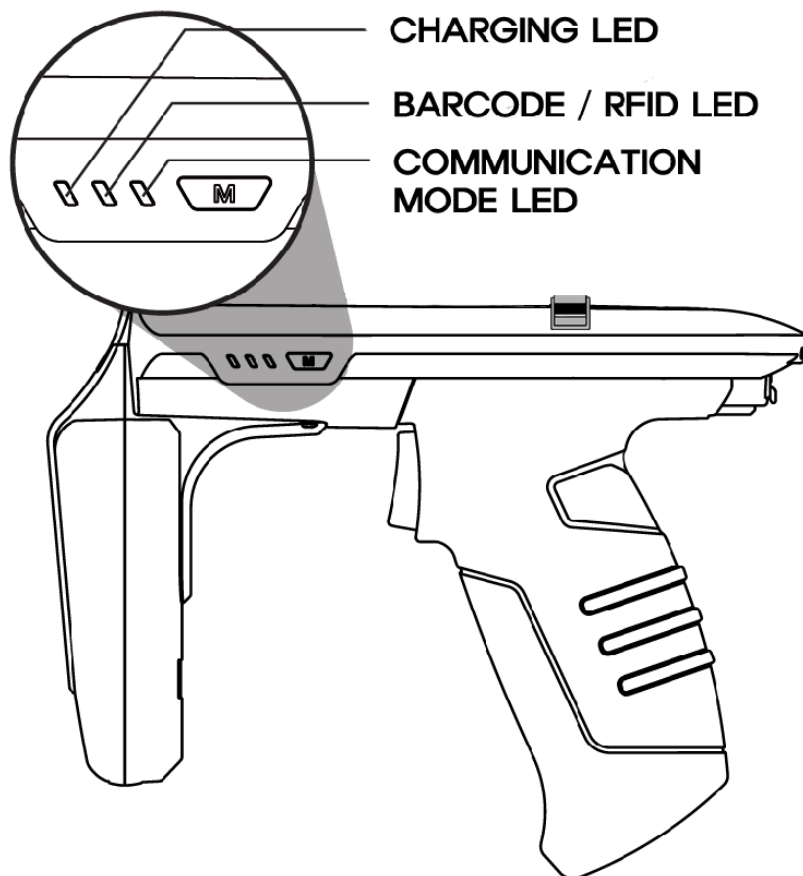

Button Operation

1. Power On

- 1) Turn on the power by pressing the power button  until the buzzer sounds.
- 2) If the communication mode LED blinks after the buzzer sounds, the power is on.



If the gun handle has been disassembled and reassembled, the instrument will not power on immediately when the power button is pressed. This is not a malfunction, but a procedure to check the battery status when first connecting the battery. In this case, if you hold down the power button longer than normal, it will power on normally.

2. Power Off

- 1) If the power button  is pressed while the power is on, the power is turned off.
- 2) If the communication mode LED turns off after the buzzer sounds, the power is off.

3. Data Communication Mode Setting

- 1) Press the communication mode switch button  to sequentially switch between 'Bluetooth data communication mode' and 'USB data communication mode'.
- 2) It takes about 2~3 seconds to change data communication mode.

4. Switch Barcode / RFID Function

Each time the Barcode/RFID toggle button  is pressed, the 'Barcode', 'RFID', 'Trigger Input' mode is sequentially switched.



'Trigger input mode' is a mode in which the barcode or RFID reading function does not operate when a trigger signal is input and only the trigger signal is input to the host device.

Charging

1. Charge using the adapter

- 1) Plug the charging adapter into the USB port on the back of the ATS200.
- 2) It is recommended to use an adapter of 5V / 2A or higher. Charging time will increase if you use an adapter with a low power output.

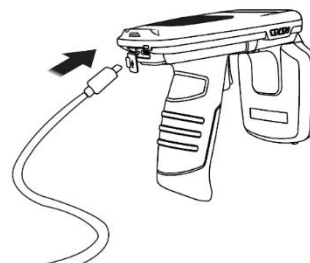

2. Charging with PC USB Port

- 1) The device is charged even when a USB cable is connected for data communication with a PC.
- 2) In this case, it is charged at a low speed and if the device and the smartphone are connected, the smartphone is not charged.

3. Charging with Cradle

- 1) Attach the product to the cradle.
- 2) After connecting the USB cable to the cradle, connect it to the charger to start charging.

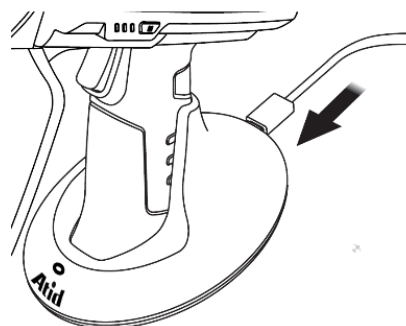
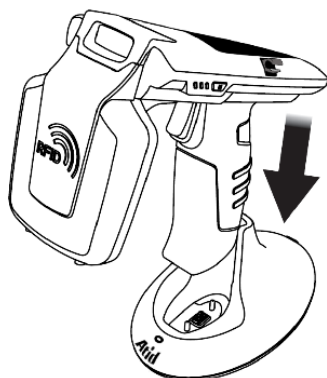

When charging in the cradle while the battery is connected to the main body, the charging LED on the main body indicates the charging progress.

4. Charging the Gun Handle

- 1) The gun handle can be charged in the cradle by itself.

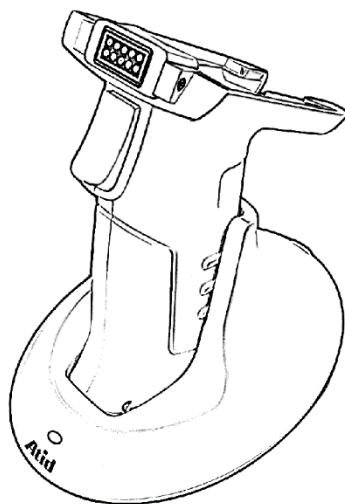

- 2) It is recommended to charge with the supplied adapter (5V/3A). If you use an adapter with a low output, the charging time will increase.
- 3) When charging the gun battery, the LED on the cradle indicates the charging status as shown below.

LED	Action	Function
Cradle LED	Orange LED On	Charging
	Green LED On	Full Charging

5. Support for simultaneous charging of Smartphones

- 4) If the AT200 is connected to the smartphone through the host connection cable, the AT200 and the smartphone are charged at the same time.
- 5) In Android and Windows, communication with AT200 through USB port is not possible while charging.
- 6) If the AT200 is charged while it is connected to the device, the charging speed will be slow.
- 7) Simultaneous charging is not possible when connected to a PC. If you want simultaneous charging, use a charging adapter.
- 8) This product does not support Quick Charge.





'Simultaneous charging of smartphones' may not be supported depending on the smartphone model.

Bluetooth Data Communication Mode Setting

1. Enter setting mode

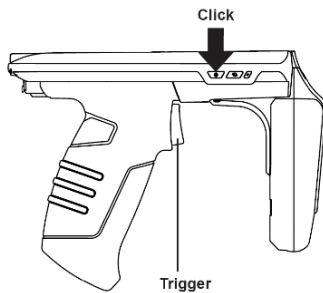
- 1) While pulling the trigger of the **ATS200**, press the power button to turn on the power.



- 2) Press the communication mode switch button  to set the communication mode LED to blink green. (set to Bluetooth mode).

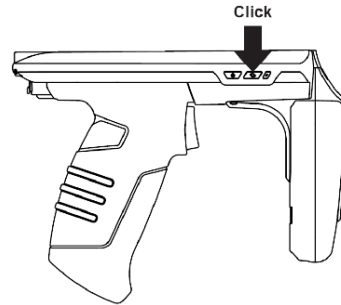

- 3) Each time you press the barcode/RFID toggle Button , 'BLE/HID/SPP' mode is switched sequentially. Communication mode LED operates differently depending on the mode.
- 4) After setting the mode you want to set, press and hold the power button to complete the setting.

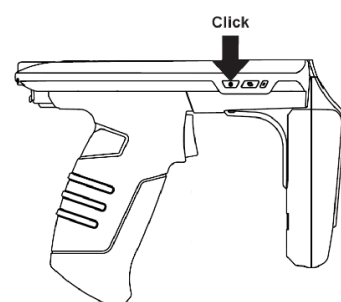
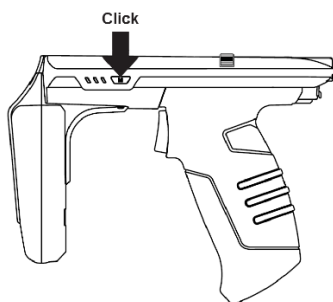

2. LED Indication for each Bluetooth Mode

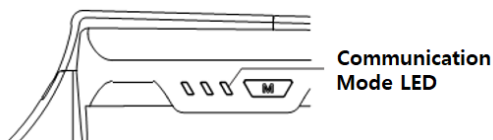

- | | |
|---------------------------------|------------|
| 1) Green LED blinks quickly | : BLE Mode |
| 2) Keep Green LED on | : HID Mode |
| 3) Green LED blinks every 2 sec | : SPP Mode |





- If the Bluetooth data communication mode setting is incorrect, it may not be able to connect to the iPhone, Android, or Windows Host device being used. Please pay attention to the settings.
- iPhone can only be connected in BLE mode.
- For Android and Windows, SPP mode or HID mode can be used. However, in HID mode, the ATS100 main body cannot be controlled by the application.

USB Data Communication Mode Setting

1. Enter Setting Mode

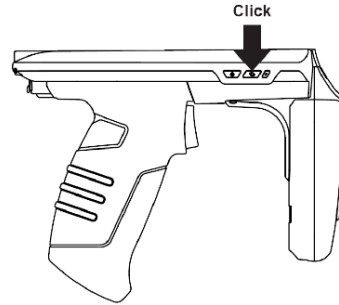
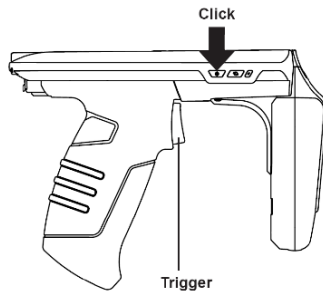
- 1) While pulling the trigger of the **ATS200**, press the Power Button to turn on the power.
- 2) Press the Communication Mode Switch Button  to set the communication mode LED to blink Red. (set to USB mode.)



- 3) Each time you press the barcode/RFID toggle Button , 'BLE/HID/SPP' mode is switched sequentially. Communication mode LED operates differently depending on the mode.
- 4) After setting the mode you want to set, press and hold the Power Button to complete the setting.

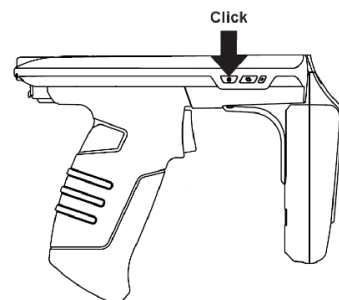
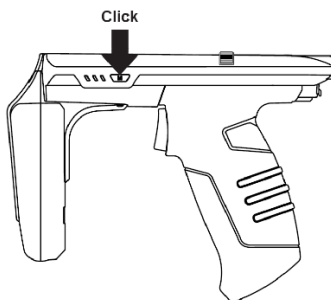

2. LED Indication for each USB Mode

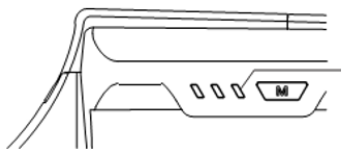

Communication Mode LED

- 1) Red LED blinks every 2 secs : VCP Mode
- 2) Keep Red LED on : HID Mode



- If the USB data communication mode setting is incorrect, it may not be able to connect to the Android or Windows device being used. Please pay attention to the settings.
- Connection with iPhone is not supported.
- For Android and Windows, SPP mode or HID mode can be used. However, in HID mode, the ATS100 main body cannot be controlled by the application.

Setting Device by Scanning Barcodes

1. Functional Description

User can easily change device settings, such as changing Bluetooth data communication mode (BLE, HID, SPP) and USB data communication mode (VCP, HID), and setting system defaults, by reading a special barcode.

- ! • This setting mode is supported from firmware version 'ats-5.1.1.11'.
- When setting with the USB cable connected, the device does not reset after setting.

2. How to set up

1) Press the power button to turn on the power.

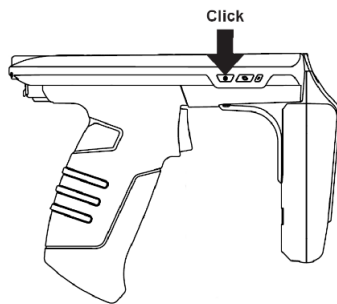

2) Press the Barcode/RFID Toggle Button  to set to Barcode mode. (In Barcode Mode, the LED lights Blue.)

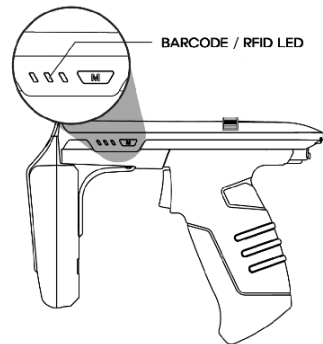

3) Aim at the barcode of the function you want to set and scan by pressing the trigger button.

4) If the setting is completed normally, the system is reset.

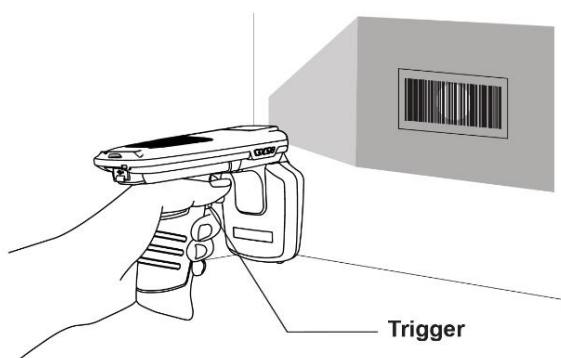

3. Device Setting Barcode



- When connected to the host device, it does not work even if the mode setting barcode is read.
- When setting with the USB cable connected, the device does not reset after setting.

1) Default setting (BT-SPP, USB-VCP Setting)



2) Bluetooth Data Communication Mode Setting

Data Communication Mode	Setting Barcode
Bluetooth SPP	<p>ATS100-BT-SPP</p>
Bluetooth HID	<p>ATS100-BT-HID</p>
BLE	<p>ATS100-BT-BLE</p>

3) USB Data Communication Mode Setting



Data Communication Mode	Setting Barcode
USB VCP	<p>ATS100-USB-VCP</p>
USB HID	<p>ATS100-USB-HID</p>

4) Setting PC/EPC data output format

- a) Set whether to transmit PC (Protocol Control) information when transmitting EPC Data of collected Tag to Host device.
- b) EPC Data of collected Tag data is transmitted as follows according to the setting.
 - PC + EPC : ex) 30001234567890
 - EPC only : ex) 1234567890



- This setting feature is supported from firmware version 'ats-5.1.2.1'.
- When setting with the USB cable connected, the device does not reset after setting.

Setting	Setting Barcode
PC + EPC	 ATS100-REPORT-PC-EPC
EPC only	 ATS100-REPORT-EPC

Using Android Host Demo Application

1. Android Host – Bluetooth Connection

- 1) Install the Demo Application (Hereinafter : Demo App) included in the provided SDK.
 - In order to connect the Android Demo App and the device, the Bluetooth Data Communication Mode of the device must be set to SPP mode.
 - Demo App for Android is available from Android version 4.2 Jelly Bean or later.
 - For the smooth operation of the app, it is recommended to use a device with Android version 6.0 or higher.
- 2) Run the downloaded Demo App with the icon shown below.
- 3) Click 'Allow' on the next screen to activate the Bluetooth function of the host device.

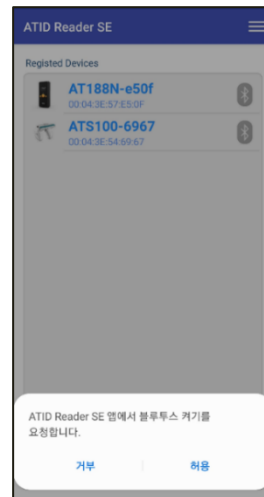

- 4) Click 'New Device' from the menu that appears when you click the  icon in the upper right corner.
- 5) Select 'BLUETOOTH' on the converted 'Regist Device' screen and click the 'Scan Device' button.

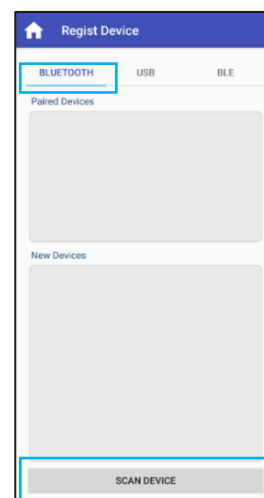
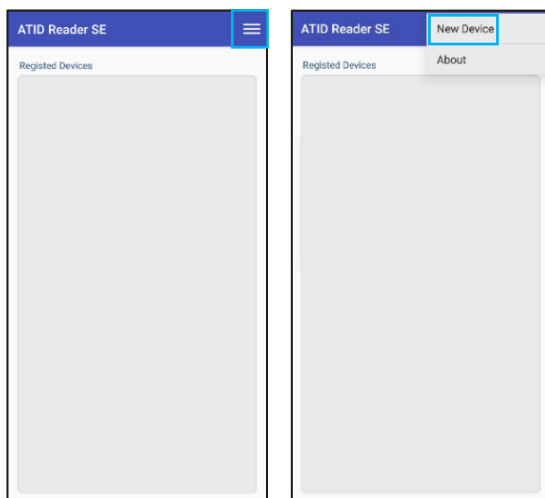

- 6) Connectable devices are displayed in 'New Devices'. If you click on the product, the device information is registered and you return to the previous screen.
- 7) Touch and hold the  icon of registered device information.

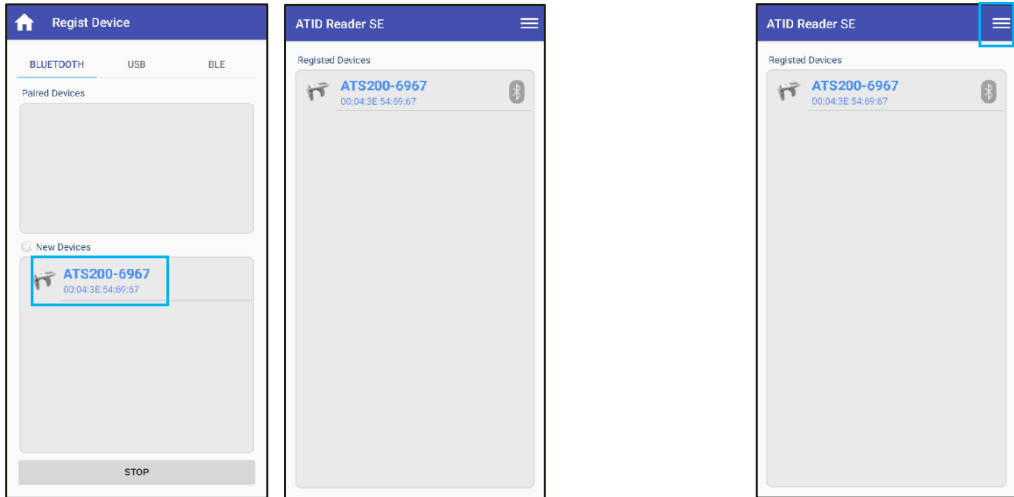

- 8) Click the 'Connect' Button among the activated menus.
- 9) When connected to the device normally, the 'Bluetooth connection request' window is activated. Click 'Pair' to connect the **ATS200** to the host device.

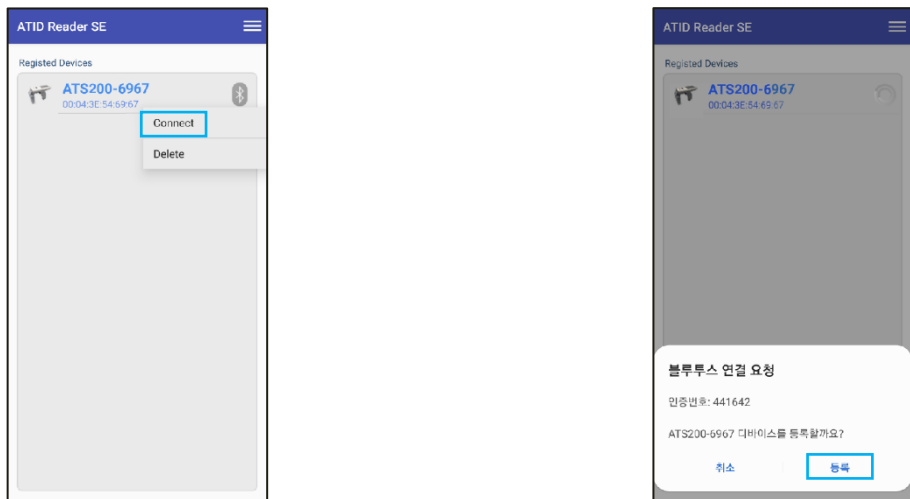

2. Android Host – Bluetooth Disconnection

- 1) While the **ATS200** is connected to the host device, touch and hold the  icon of the registered device on the 'Registered Devices' selection screen.
- 2) Click 'Disconnect' in the activated menu to disconnect the connection between the host device and the **ATS200**.

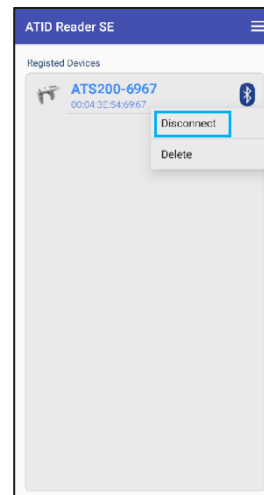
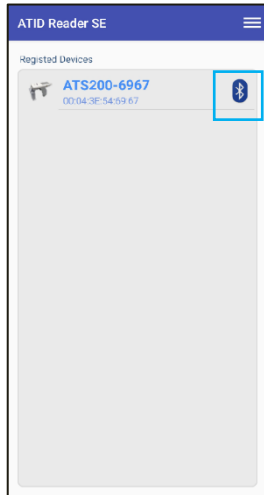

3. Android Host – Remove Bluetooth Connection Information

- 1) While the **ATS200** is connected to the host device, touch and hold the  icon of the registered device on the 'Registered Devices' selection screen.
- 2) Click 'Delete' in the activated menu to delete **ATS200** device registration information.

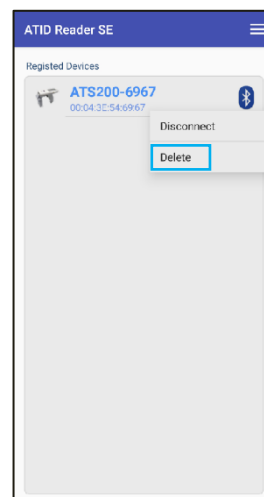
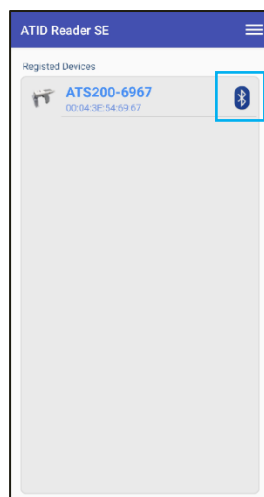

Even if the connected device is deleted from the app list, it is not removed from the Android device's Bluetooth connection list.

4. Android Host – USB Connection



The device must have USB data communication mode set to VCP mode in order for the demo app for Android and the device to connect to the USB port.

- 1) Connect the USB cable for host connection to the smartphone USB port.
- 2) Click 'New Device' from the menu that is activated when you click the  icon in the upper right corner.

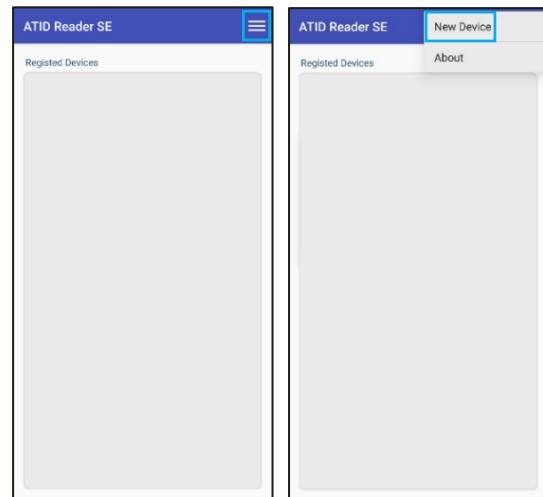
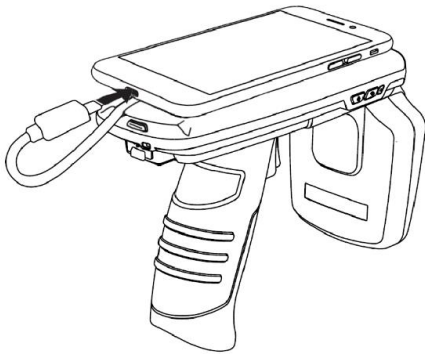

- 3) On the converted 'Regist Device' screen, select the 'USB' menu and click the 'Scan Device' button.
- 4) Connectable devices are displayed in the 'New Devices' item. If you click on the product, the device information is registered and you return to the previous screen.

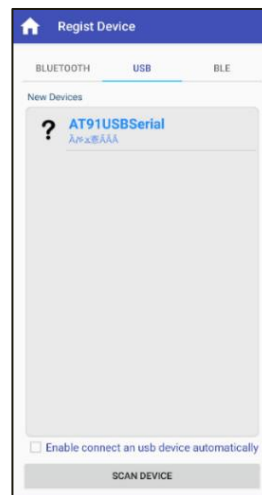
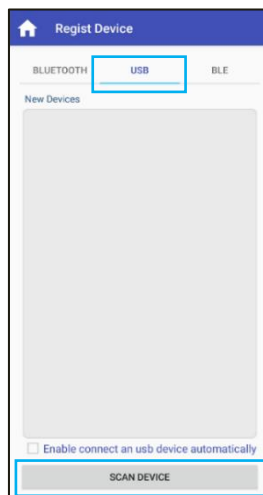

If you check the 'Enable connect an usb device automatically' option, it will be connected automatically from the next connection.

- 5) Touch and hold the  icon to the right of the registered device information.
- 6) Click the 'Connect' button among the activated menus.

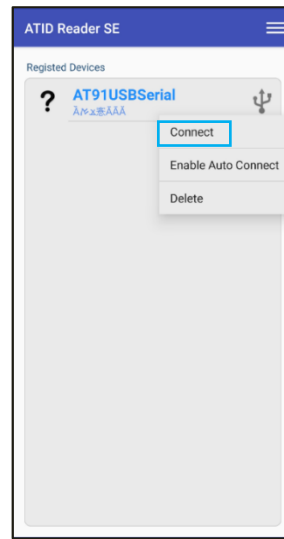
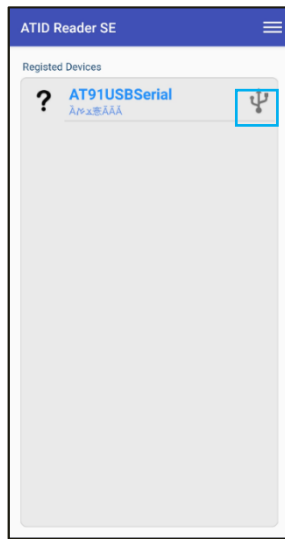

- 7) When connected to the device normally, a window asking whether to allow access is activated. Click 'OK' to connect the **ATS200** to the host device.



5. Android Host – USB Disconnection

- 1) With the **ATS200** connected to the host device, touch and hold the registered device information  icon on the 'Registered Devices' selection screen.
- 2) Click 'Disconnect' in the activated menu to disconnect the connection between the host device and the **ATS200**.

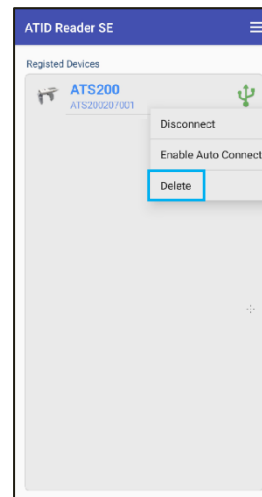

6. Android Host – Remove USB Connection Information

- 1) With the **ATS200** connected to the host device, touch and hold the registered device information  icon on the 'Registered Devices' selection screen.
- 2) Click 'Delete' in the activated menu to delete **ATS200** device registration information.

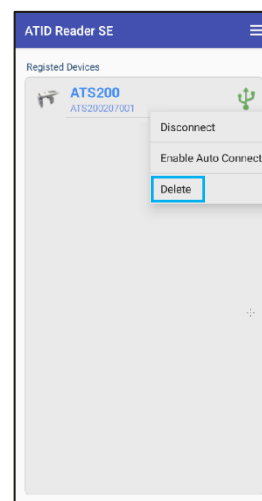
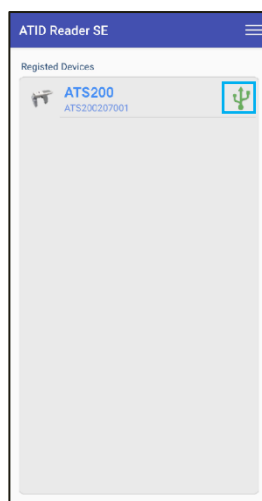

7. Android Host - RFID Tag Scan



In order to connect the Android Demo App and the device, the Data Communication Mode of the device must be set to 'SPP' for Bluetooth connection and 'VCP' for USB connection.

- 1) After completing the connection with the host device, touch and hold the device name shown below on the connected device on the 'Registered Devices' screen to enter the 'Inventory' screen.
- 2) Click 'RFID' in the menu at the top of the 'Inventory' screen.



To enter the 'Inventory' screen, you must touch the device name for a certain period of time.

- 3) Click the 'Start' button on the Demo App or pull the **ATS200** trigger to start data reading.
- 4) The collected data is displayed on the 'Data' screen of the Demo App. Click the 'Stop' button on the Demo App or release the **ATS200** trigger to stop data collection.

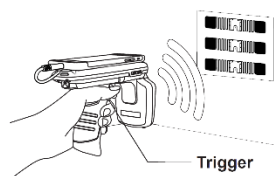

8. Android Host – Barcode Scan



In order to connect the Android Demo App and the device, the data communication mode of the device must be set to 'SPP' for Bluetooth connection and 'VCP' for USB connection.

- 1) After completing the connection with the host device, touch and hold the device name shown below on the connected device on the 'Registered Devices' screen to enter the 'Inventory' screen.
- 2) Click 'BARCODE' in the menu at the top of the 'Inventory' screen.

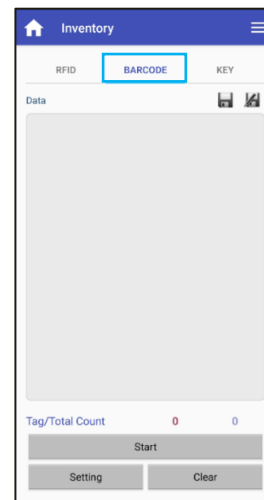
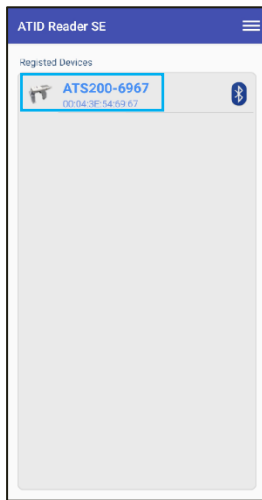

- To enter the 'Inventory' screen, you must touch the device name for a certain period of time.
- If you select the 'BARCODE' menu on the 'Inventory' screen, if the current setting of ATS100 is RFID mode, it is automatically changed to barcode mode. The reverse works the same.

- 3) Click the 'Start' Button on the Demo App or pull the **ATS200** trigger to start data reading.
- 4) If the barcode is read normally, the collected data is displayed on the 'Data' screen of the Demo App.

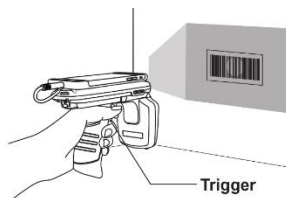

9. Android Host – Demo Application Menu

As shown in the following figure, if you touch the  icon on the top right of the Inventory screen or swipe the screen from left to right with your finger, you can see the demo menu appear. In this menu, you can check device information and make basic settings.

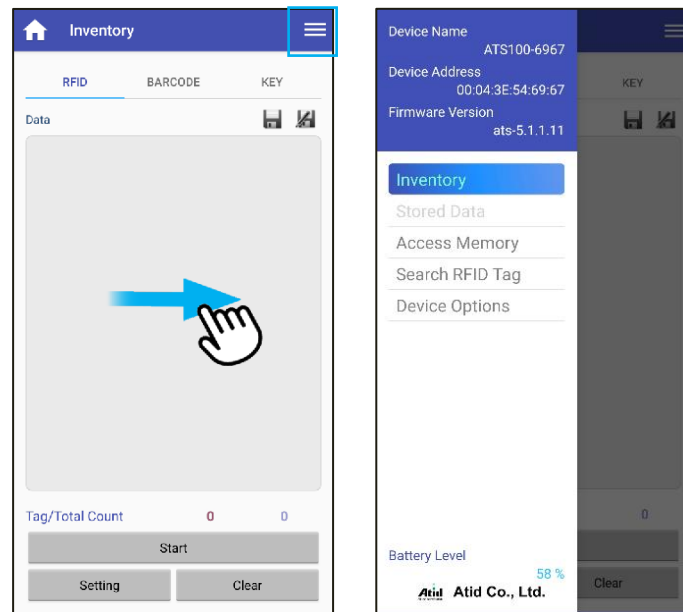

- 1) **Device Name** : Device name composed of device name and Bluetooth MAC Address.
- 2) **Device Address** : Bluetooth MAC Address of the device.
- 3) **Firmware Version** : The firmware version currently installed in the device.
- 4) **Inventory** : Returns to the Inventory screen. You can also return by touching an area other than the menu.
- 5) **Access Memory** : Enters Memory Access mode of Tag.
- 6) **Search RFID Tag** : Enters the Search RFID Tag mode.
- 7) **Device Options**
 - **Firmware Version**
 - **Serial No** : Displays the serial number information of the device.
 - **Auto Off Time** : Set the time to turn off the device when not in use.
 - **Button Mode** : Sets the buzzer sound when the button is pressed.
 - **Button Notify** : Set whether to operate the buzzer and vibrator when the button is pressed.
 - **Alert Notify** : Set whether to operate the buzzer and vibrator when a notification occurs.
- 8) **Battery Level** : Displays the current remaining battery status.



[For details on how to use the Demo App, refer to the 'ATID Reader Demo Guide for Android' document included in the SDK.](#)

Using Windows Host Demo Application

1. Windows Host – Bluetooth Connection

To transmit/receive data to/from Windows platform devices using Bluetooth, **ATS200** requires a PC with built-in Bluetooth function or a dedicated Bluetooth dongle. This chapter describes the Bluetooth connection method for Windows 7 and Windows 10, which are representative Windows platforms.

- For details related to the Bluetooth function of the host device, please check with the place of purchase of the PC or the person in charge of product installation.
- In this chapter, it is assumed that the Bluetooth-related driver is installed normally.
- For any problems that occur while using the product or during the installation process, please contact the dealer or manufacturer where you purchased the product.
- If the Bluetooth driver is not installed normally, or if a special driver supported separately by Windows 7 and Windows 10 OS is used, the contents of this manual may not match.



2. Windows Host - Windows 7 Platform

- 1) Set the communication mode of **ATS200** to 'Bluetooth Data Communication Mode' and set it to SPP mode.
- 2) Select 'Start → Control Panel → Devices and Printers → Add a Device'.

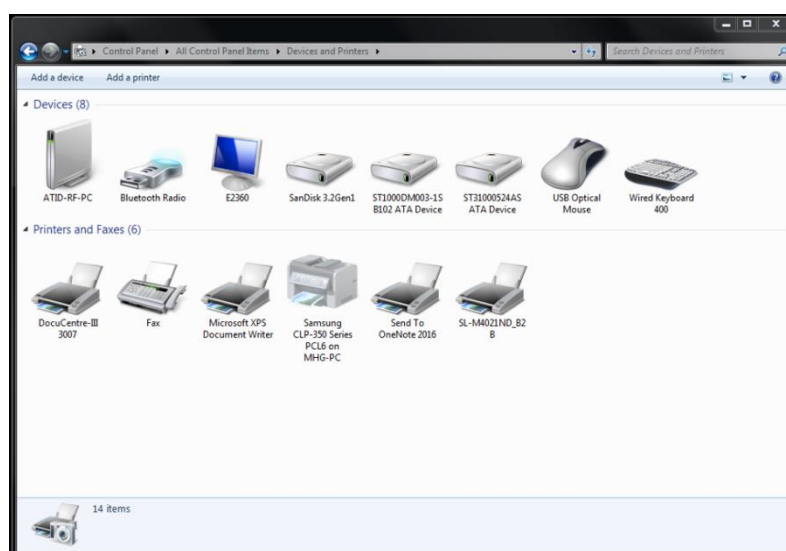

- 3) The Bluetooth device is automatically searched. After selecting the 'ATS200-XXXX' that you want to connect to, press 'Next' to proceed with adding a device.

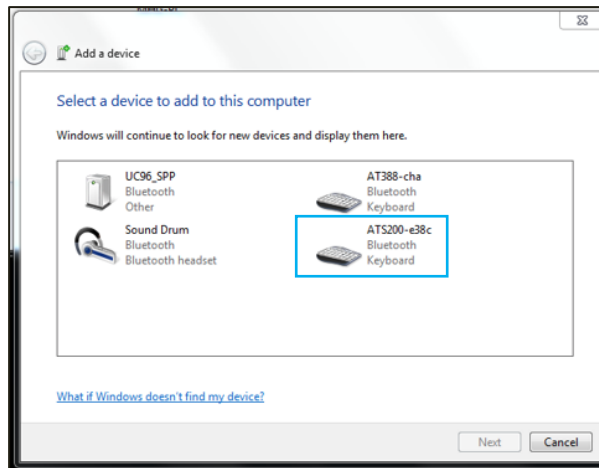

- 4) When the connection code confirmation window is displayed, click 'Next' to proceed. The connection code does not need to be specially changed.



- 5) After a while, Windows7 will automatically search for the driver and proceed with the installation, and the screen will display a message Add device complete.

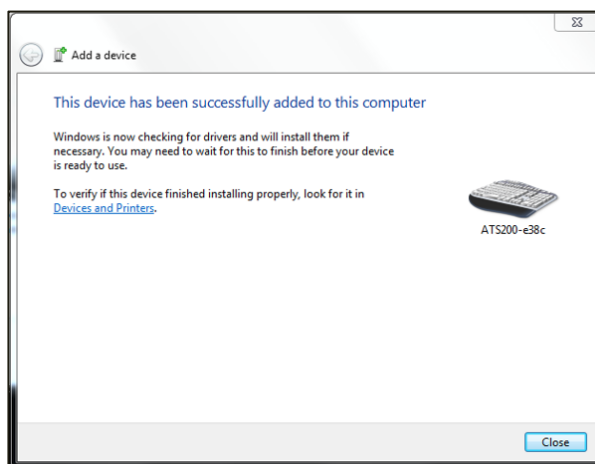

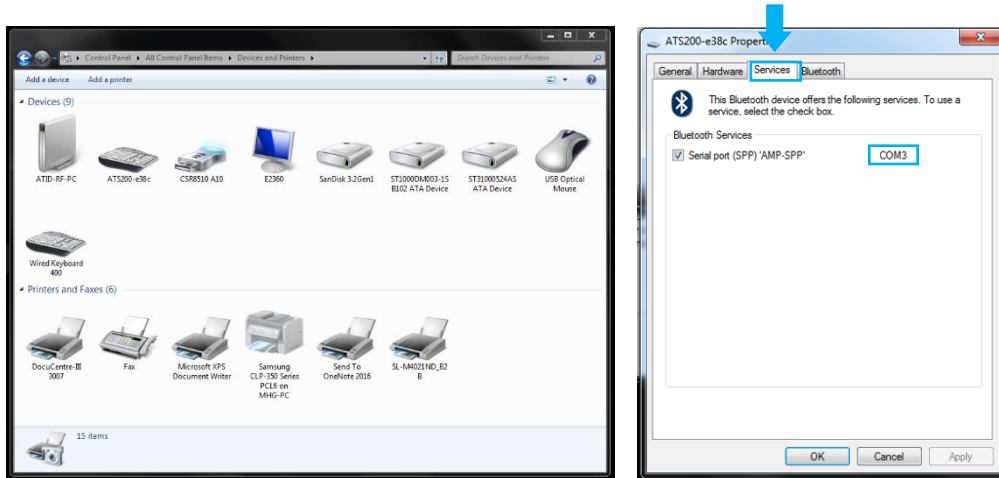

- Double-click the newly added '**ATS200-XXXX**' in 'Control Panel → Devices and Printers' to display its properties, and then move to the 'Service' tab.



- After checking all the services that appear in the Bluetooth service, click the OK button to finish adding services and adding Bluetooth devices. From this menu, user can find the COM port information assigned to the Bluetooth device.

3. Windows Host - Windows 10 Platform

- Set the communication mode of **ATS200** to 'Bluetooth Data Communication Mode' and set it to 'SPP' mode.
- Enter the Windows Settings menu through '  Start →  Settings' of Windows.
- Select 'Device' menu in Windows settings.

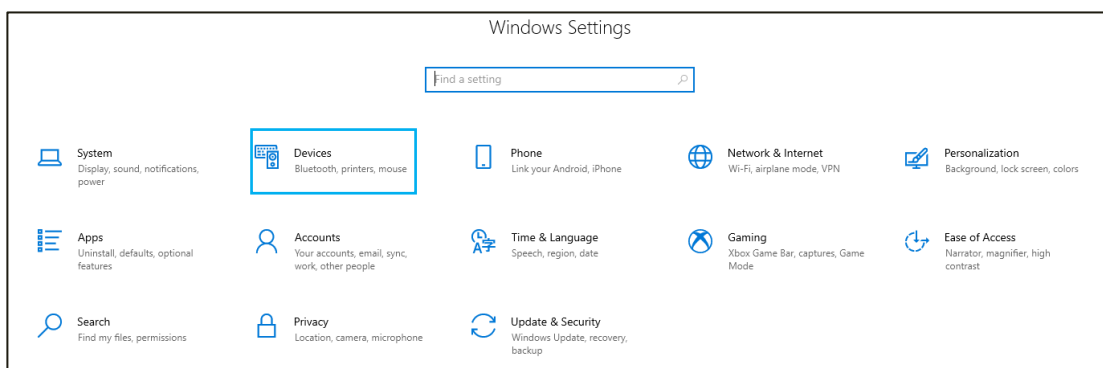

- Check that the Bluetooth function is turned on. If it is off, turn on the Bluetooth function.

- 5) Select 'Add Bluetooth or other device' menu.

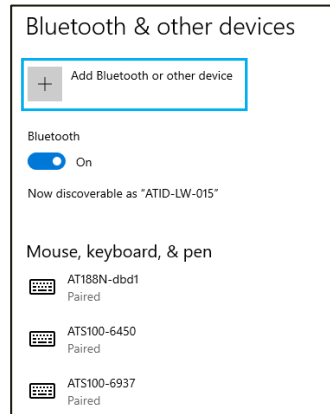

- 6) Select the device type to add as Bluetooth. When selected, it starts searching for nearby Bluetooth devices that are requesting pairing.

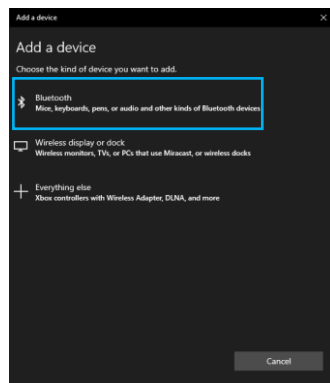

- 7) If you click the device you want to connect to among the found Bluetooth devices, the pairing information screen of the target device is activated. After checking that it matches information of the screen of **ATS200**, if it matches, click the 'Connect' button.

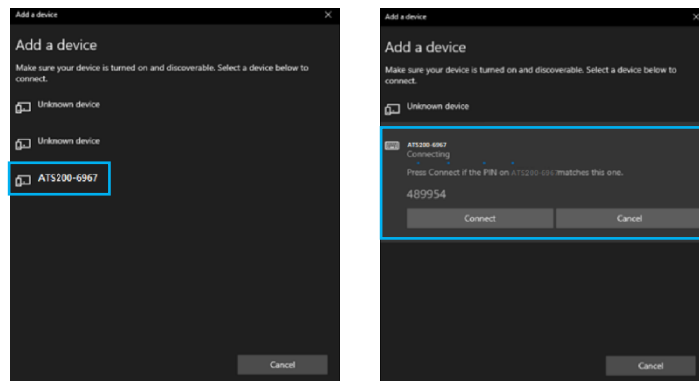

The 4 digits after the device name to be searched are the last 4 digits of the Bluetooth Module MAC Address. This 4 digit value is entered as a different value for all devices.

- 8) When pairing is completed normally, 'Your device is ready to go!' message is displayed. Click the Done button to complete the pairing process.

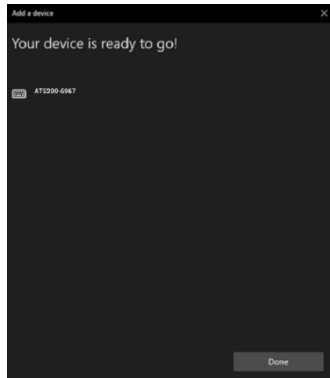

- 9) When the device is added successfully, the device will be registered with the message 'Paired'.

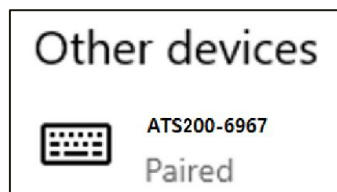

The COM Port information assigned to the device can be checked in the 'Hardware' tab of the 'Properties' of the connected device in 'Devices and Printers' of the control panel.

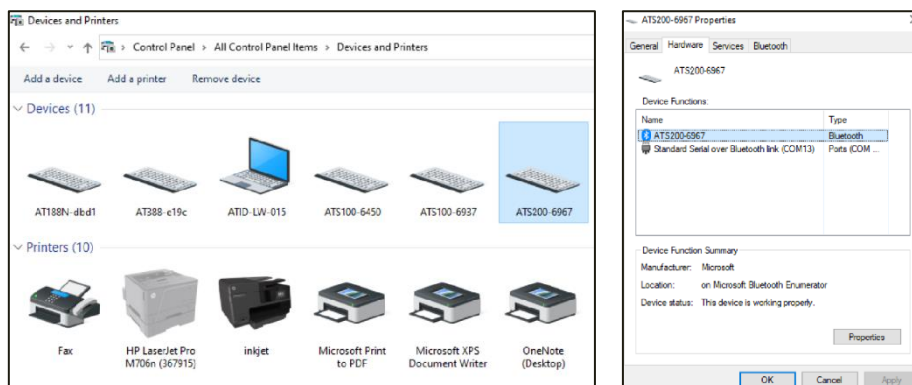

- 10) After confirming that the **ATS200** and the host device are connected, set the desired operation mode before use.

4. Windows Host - USB Connection

A USB cable is required to transmit/receive data to/from a Windows platform device using the ATS200 USB interface.

- For USB connection with Windows Host, the communication mode setting of the device must be set to USB data communication mode.



- The USB data communication mode of the device must be set to VCP mode.
- Check whether '.NET Framework 3.5' is installed.

- 1) Turn on the product and set the communication mode to 'USB Data Communication Mode'.
- 2) Plug the supplied USB cable into the USB port on the back of the ATS200.

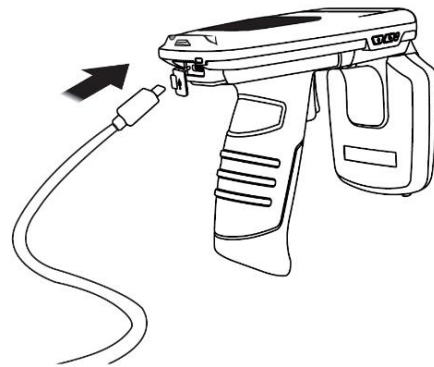
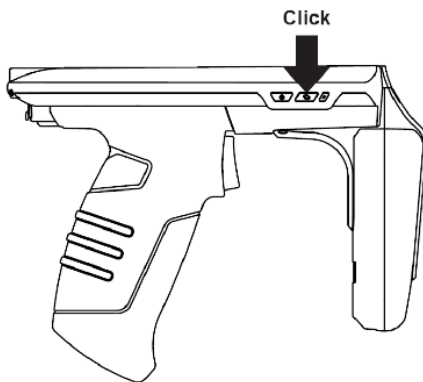

- 3) Connect the USB cable to the PC.

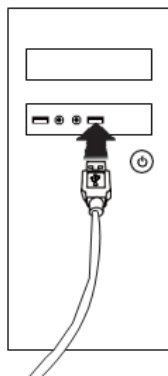

- 4) Check the COM Port assigned to the machine in Device Manager in Control Panel.

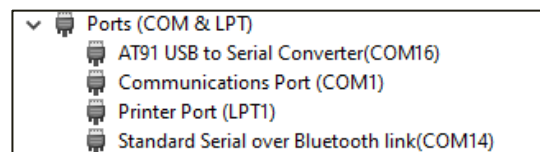

The COM port number assigned to the device differs depending on the situation of the Host PC to which the device is connected.

5. Windows Host – Demo Application Connection

- 1) Run the Demo App, select the device you want to connect to the 'Device' item, and select the 'COM Port' number assigned to the device.

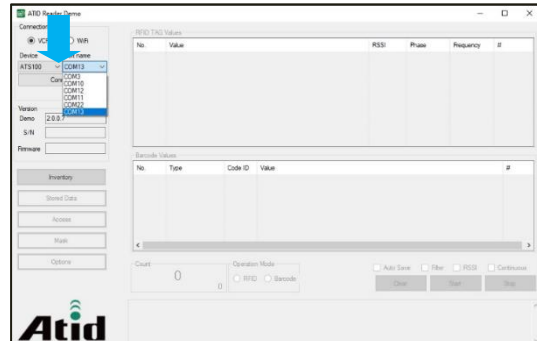
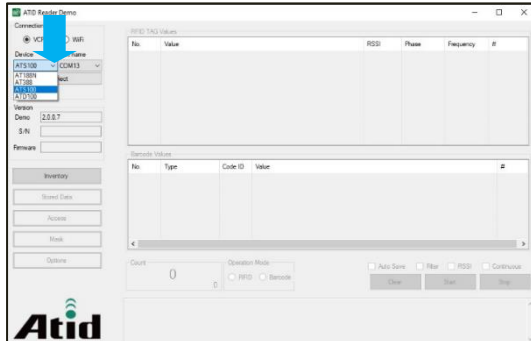

- If the 'Port name' does not match the device to be connected, check the communication mode status and driver installation status again.
- If there is a problem installing the driver for Windows, please manually install the USB driver distributed with the SDK.

- 2) Click the 'Connect' button to connect the **ATS200** to the host device. When the connection is completed normally, the buttons of the demo app are also activated.

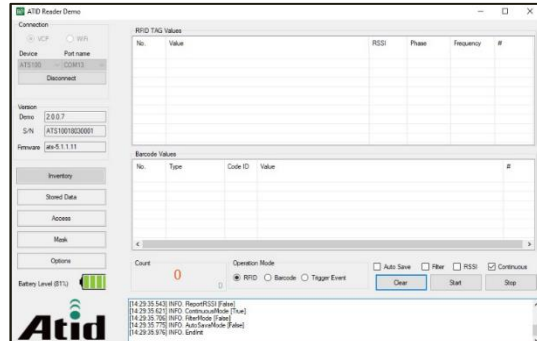
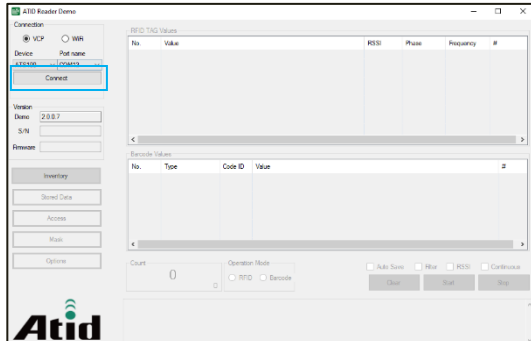

- 3) If you want to disconnect from the host device, click the 'Disconnect' button to disconnect.

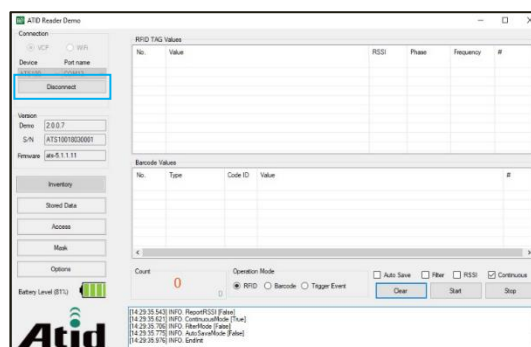

6. Windows Host - RFID Tag Scan

- 1) Referring to the above, connect the **ATS200** to the host device and connect the Demo App.
- 2) Check if 'Operation Mode' is set to RFID, and if not, set it to RFID.

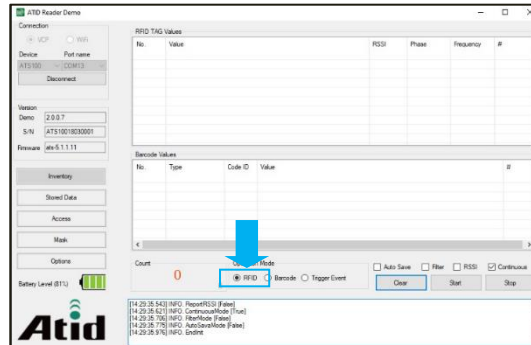

- 3) Click the 'Start' button on the demo app or pull the trigger of **ATS200**.

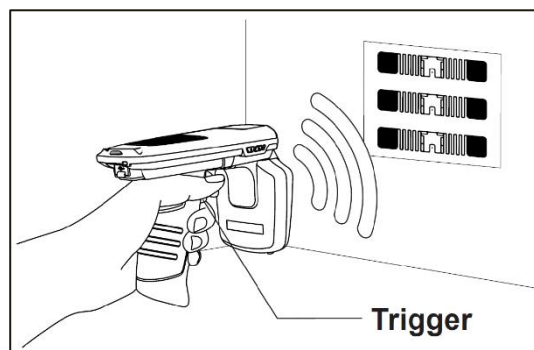
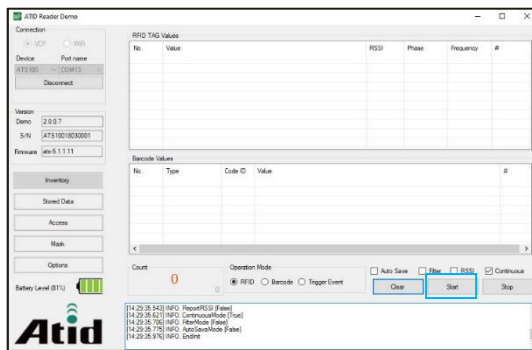

- 4) If the 'Continuous' item is checked, the tag scan stops when the 'Stop' button is pressed or the trigger is released. A list of recognized tags is displayed in 'RFID TAG Values'.

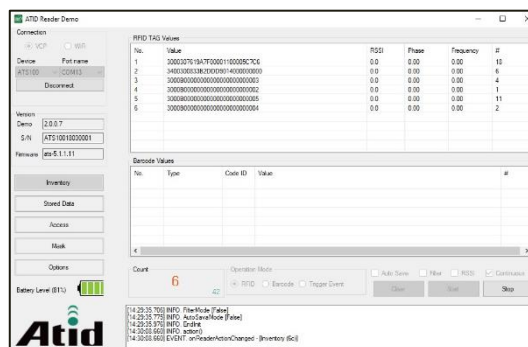

7. Windows Host – Barcode Scan

- 1) Referring to the above, connect the **ATS200** to the host device and connect the Demo App.
- 2) Check if 'Operation Mode' is set to 'Barcode', if not, set it to 'Barcode'.

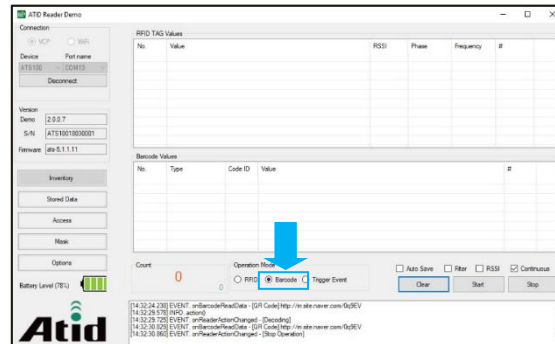

- 3) Click the 'Start' button on the Demo App or pull the trigger of **ATS200**.

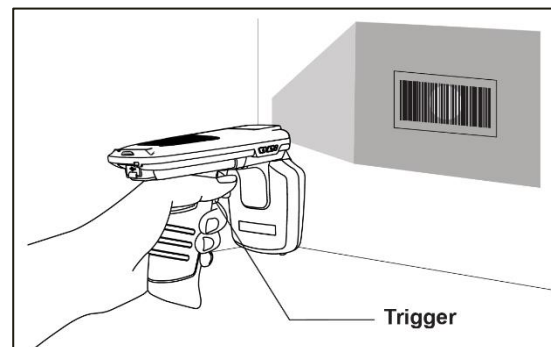
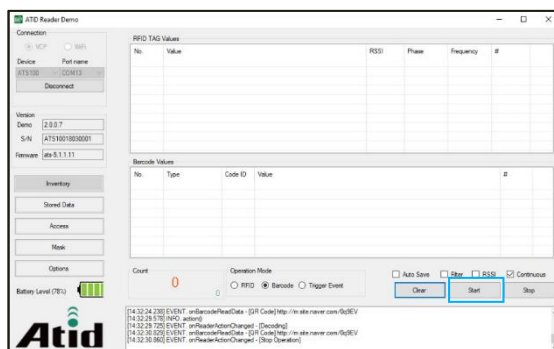

- 4) If the 'Continuous' item is checked, the barcode scanning stops when the 'Stop' button is pressed or the trigger is released. A list of recognized tags is displayed in 'Barcode Values'.

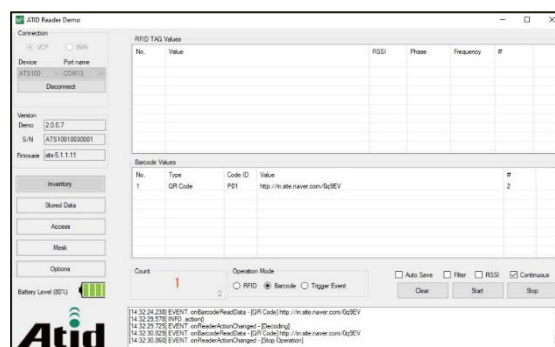

For details on how to use the Demo App, refer to the 'ATID Reader Demo Guide for Windows' document included in the SDK.

Using iOS Host Demo Application

- 1) In order to 'transmit/receive' data with iOS platform devices for **ATS200**, the 'Bluetooth Data Communication Mode' setting of **ATS200** must be set to BLE mode.
- 2) User can download the Demo App through the 'App Store'.

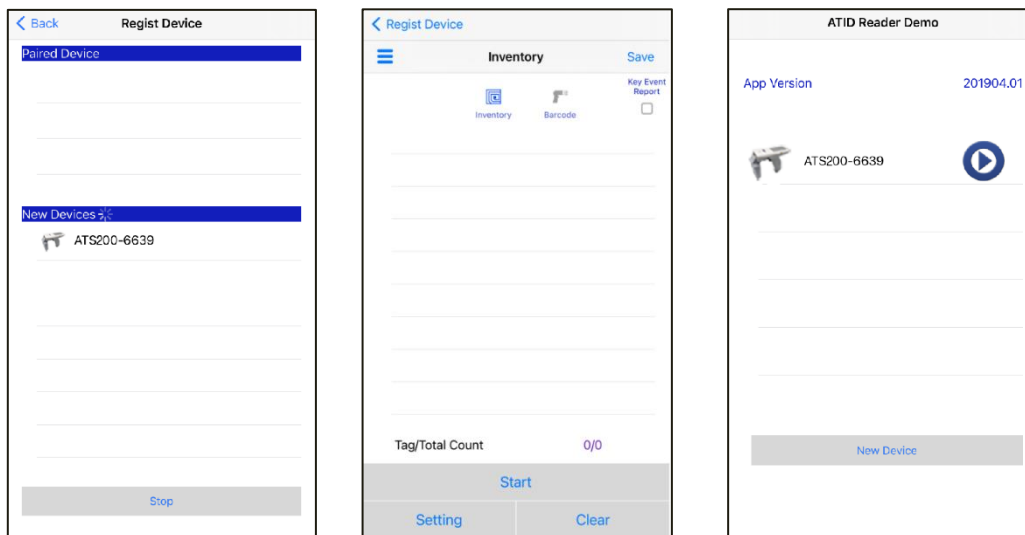

- The demo app is available from iOS version 10.2 or later.
- For details on how to use the demo app, refer to the 'ATID Reader Demo Guide for iOS' document included in the SDK.

Firmware Update

This product may be updated in the future to enhance its functionality and performance. If there is a problem during Firmware's update operation, the product may not be recoverable. So, if you don't have knowledge of software and hardware, please contact your place of purchase or manufacturer for updates.

1. Firmware Update Preparation

- 1) PC with Windows 7 or higher version (USB 2.0 Port)
- 2) ATS200
- 3) USB Type-C Cable
- 4) Firmware File (xxx.bin)
- 5) Firmware Update Tool (Available from reseller or manufacturer if required)

2. Firmware Update Procedure

- 1) Save the firmware file in a specific folder on your PC.
- 2) Execute the firmware update program.

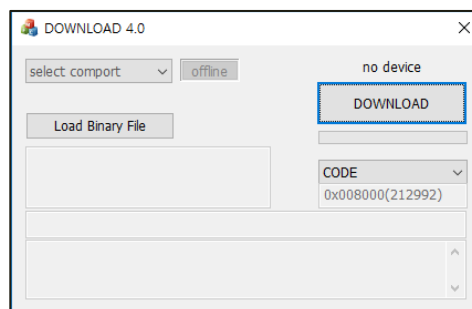

- 3) After clicking the 'Load Binary File' button, designate the folder where the firmware file was previously saved.

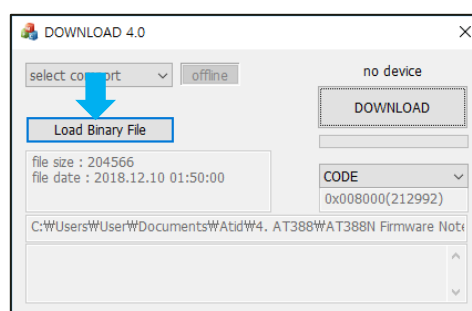

- 4) Connect **ATS200** to PC using USB Cable.

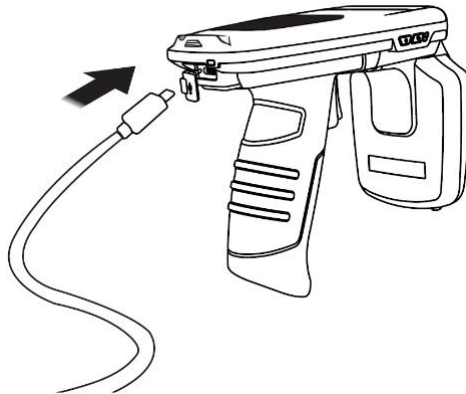

- 5) Set the communication mode setting of **ATS200** to USB mode, VCP.
- 6) Click the 'select comport' button of Firmware Download Tool. Then, select the COM Port assigned to **ATS200** connected to your PC.

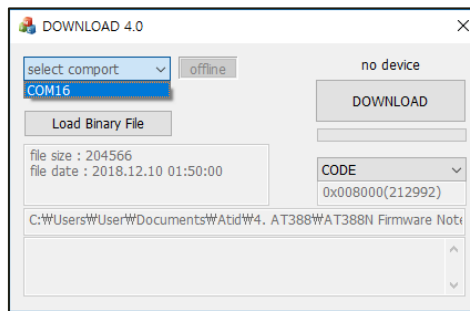

- COM Port is assigned a different number depending on the PC situation.
- Control Panel 'Device Manager → Ports (COM & LPT)' Please check the COM Port number assigned to 'AT91 USB to Serial Converter' before entering.

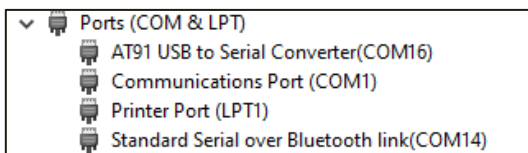

- 7) Click the 'offline' button to attempt to connect to the device. When connected normally, the button changes to 'online' and displays the current firmware version.

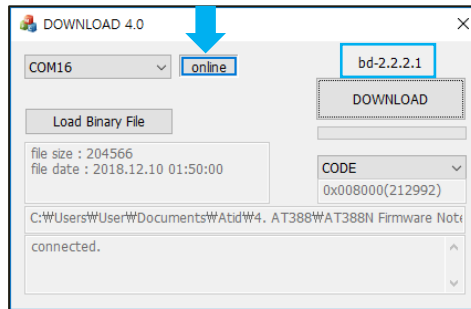

- 8) Click the 'DOWNLOAD' button to start the firmware update.

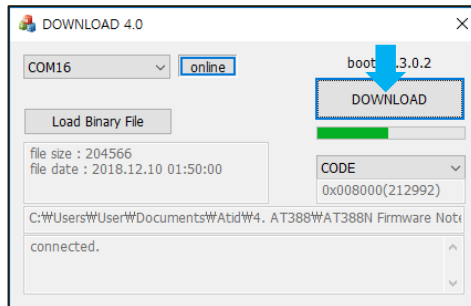

- If the update is interrupted while the update is in progress, the device may become unusable.
- The update may fail due to external factors. In this case, please try again.

- 9) After a while, the product will automatically restart when the download is complete.

SDK (Software Development Kit)

When the device operates in interactive mode, a separate program must be developed by referring to the SDK provided by ATID in order to utilize the data transmitted from the host device. ATID Bluetooth Reader SDK supports three platforms: Android, Windows, and iOS.

Platform	Development Tool	Development Language
Android	Andorid Studio	Java
Windows	Visual Studio	.NET Framework (C#), UWP (C#)
iOS	XCODE	Objective-C
SDK Package Configuration	Details	
Demo	Demo Application	
Doc	Development documents such as user guides / manuals, programmer guides, demo guides, etc.	
Lib	Library for application development	
Sample	Sample Code	
USB Drive for Windows	Windows USB Driver of ATID Bluetooth Reader	



Each folder is composed of subfolders for each platform as shown below.

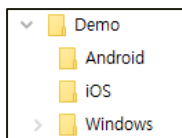

Product Warranty

1. ATS200 Product Details

For more information on product details ATS200, please visit the address below.

<http://www.atid1.com>

2. SDK Download

If you need an ATS200 SDK, please contact us or the place of purchase.

3. Warranty and Technical Support

All ATID products can be repaired free of charge for one year based on the product manufacturing date. However, in principle, any defects caused by customer carelessness in use shall be repaired even during the free repair period.

For warranty, technical support and inquiries on this product, please contact the distributor or ATID.

4. Certifications

- 1) This product is KC, FCC, CE and TELEC certified, but we are not responsible for any issues arising during use outside of the certified area. For more details, please contact the distributor or ATID.
- 2) **For a Class B digital device or peripheral, the instructions furnished the user shall include the following or similar statement, placed in a prominent location in the text of the manual:**

NOTE: This equipment has been tested and found to comply with the limits for a Class B digital device, pursuant to part 15 of the FCC Rules. These limits are designed to provide reasonable protection against harmful interference in a residential installation. This equipment generates, uses and can radiate radio frequency energy and, if not installed and used in accordance with the instructions, may cause harmful interference to radio communications. However, there is no guarantee that interference will not occur in a particular installation. If this equipment does cause harmful interference to radio or television reception, which can be determined by turning the equipment off and on, the user is encouraged to try to correct the interference by one or more of the following measures:

- Reorient or relocate the receiving antenna.
- Increase the separation between the equipment and receiver.
- Connect the equipment into an outlet on a circuit different from that to which the receiver is connected.
- Consult the dealer or an experienced radio/TV technician for help.

- 3) **This device complies with Part 15 of the FCC Rules. Operation is subject to the following two conditions: (1) this device may not cause harmful interference, and (2) this device must accept any interference received, including interference that may cause undesired operation.**

FCC CAUTION:

Any changes or modifications in construction of this device which are not expressly approved by the party responsible for compliance could void the user's authority to operate the equipment.

FCC NOTE:

The manufacturer is not responsible for any radio or TV interference caused by unauthorized modifications to this equipment. Such modifications could void the user's authority to operate the equipment.

4) **Label Requirements**

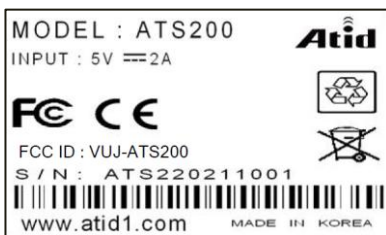

5) **FCC RF Exposure Information and Statement**

This device meets the government's requirements for exposure to radio waves. The guidelines are based on standards that were developed by independent scientific organizations through periodic and thorough evaluation of scientific studies. The standards include a substantial safety margin designed to assure the safety of all persons regardless of age or health. The SAR limit of USA (FCC) is 1.6 W/kg averaged. Device types: UHF RFID Reader (FCC ID: VUJ-ATS200) has also been tested against this SAR limit. SAR information on this and other pad can be viewed on-line at <http://www.fcc.gov/oet/ea/fccid/>. Please use the device FCC ID number for search. This device was tested simulation typical 50 mm for RFID transmit to body. To maintain compliance with FCC RF exposure requirements, should maintain a separation distance between the user's bodies mentioned above

ATID Co.,Ltd.

Address : #1402, 83, Gasan Digital-1ro, Geumcheon-gu, Seoul, Republic of Korea (Zip code. 08589)

Phone : +82-2-544-1436

Fax : +82-2-859-0045

Homepage : www.atid1.com

Email : inquiry@atid1.com

The contents of the user manual are subject to change without notice for product specifications change or improvement.